

# CPVC DUCT PIPE & FITTINGS

For Harrison Fume Exhaust Systems



HARRISON MACHINE & PLASTIC  
CORPORATION

Dimensions Catalog



# Table of Contents

<u>Description</u>	<u>Page No.</u>
CORZAN® CPVC Pipe	3
Bell Dimensions	4
90° Elbow	4
45° Elbow	5
Coupling	5
Reducer Coupling	6
Cap	7
True Wye	7
45° Wye	8
Tee	9
Rainskirt	10
Rain Cap 'Style A'	11
Rain Cap 'Style B'	12
Blind Flange	13
Butterfly Damper	14
Socket Flange	15
Blastgate Damper	16
Flex Hose Adapter – Bell End	17
Flex Hose Adapter – Plain End	18
Hoods	19
Transitions	19

**Note:** The dimensions shown on the following pages of this catalog are essentially shown as “Center to End” dimensions, which apply to both belled end as well as plain end fittings. To determine “take-out” dimensions for belled end fittings, refer to the bell depths below to make appropriate calculations. 2

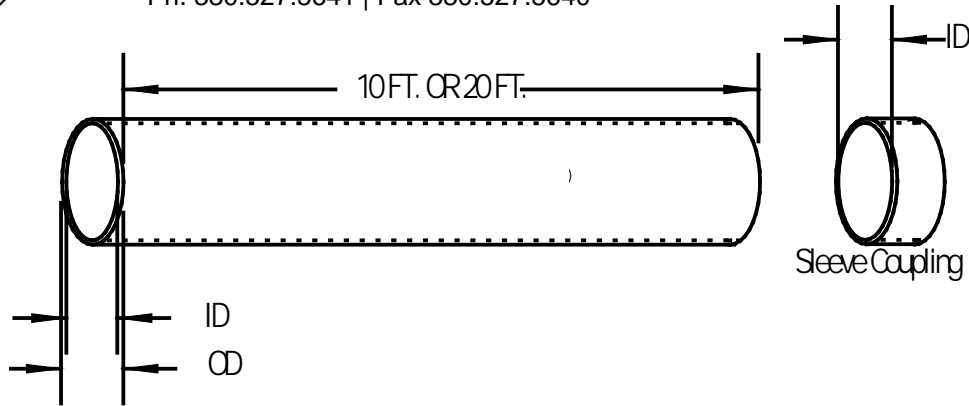

<b>Corzan® CPVC Pipe</b>						
<b>Part No.</b>	<b>Size</b>	<b>(O.D.)</b>	<b>(I.D.)</b>	<b>Wall</b>	<b>Approx. Wgt/Ft (Lbs)</b>	<b>Standard Length</b>
	<b>Extruded</b>					
1833-PP-02	2"	2.375"	2.047"	0.154"	0.803	10 ft. or 20 ft.
1833-PP-03	3"	3.500"	3.042"	0.216"	1.660	10 ft. or 20 ft.
1833-PP-04	4"	4.500"	3.998"	0.237"	2.363	10 ft. or 20 ft.
1833-PP-05	5"	5.563"	5.016"	0.258"	2.874	10 ft. or 20 ft.
1833-PP-06	6"	6.625"	6.250"	0.187"	2.555	10 ft. or 20 ft.
1833-PP-08	8"	8.625"	8.250"	0.187"	3.349	10 ft. or 20 ft.
1833-PP-10	10"	10.750"	10.380"	0.187"	4.192	10 ft. or 20 ft.
1833-PP-12	12"	12.750"	12.380"	0.187"	4.986	10 ft. or 20 ft.
1833-PP-14	14"	14.000"	13.630"	0.187"	5.485	10 ft. or 20 ft.
1833-PP-16	16"	16.000"	15.630"	0.187"	6.273	10 ft. or 20 ft.
1833-PP-18	18"	18.000"	17.630"	0.187"	7.58	10 ft. or 20 ft.
1833-PP-20	20"	20.000"	19.500"	0.219"	9.146	10 ft. or 20 ft.
1833-PP-24	24"	24.000"	23.500"	0.250"	12.536	10 ft. or 20 ft.
	<b>Rolled</b>					
1833-PP-22	22"	22.000"	21.626"	0.187"	9.880	4 ft. w/ Coupling
1833-PP-26	26"	26.000"	25.626"	0.187"	11.670	4 ft. w/ Coupling
1833-PP-28	28"	28.000"	27.626"	0.187"	12.56	4 ft. w/ Coupling
1833-PP-30	30"	30.000"	29.626"	0.187"	13.46	4 ft. w/ Coupling
<b>Duct diameter thru 60" available. Contact factory for details.</b>						

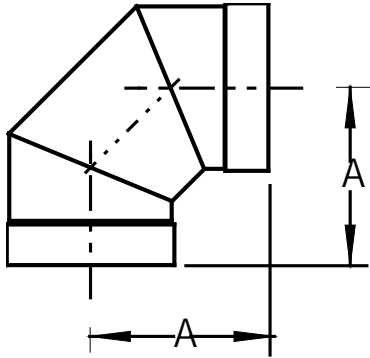

<b>90° Elbow Belled (3 piece)</b>			
<b>Part No.</b>	<b>Size</b>	<b>A</b>	<b>Approx. Wgt (Lbs)</b>
1834-90-02	2 "	7.187 "	1
1834-90-03	3 "	9.000 "	2
1834-90-04	4 "	9.250 "	3
1834-90-05	5 "	9.937 "	5
1834-90-06	6 "	10.500 "	4
1834-90-08	8 "	11.437 "	6
1834-90-10	10 "	14.750 "	9
1834-90-12	12 "	15.625 "	12
1834-90-14	14 "	15.750 "	14
1834-90-16	16 "	18.000 "	19
1834-90-18	18 "	19.062 "	24
1834-90-20	20 "	21.500 "	33
1834-90-24	24 "	23.500 "	49

<b>Bell Dimensions</b>	
<b>Size</b>	<b>Socket Depth</b>
2 "	1.50"
3 "	1.75"
4 "	2.25"
5 "	2.75"
6 "	2.00"
7 "	2.25"
8 "	2.25"
9 "	2.25"
10 "	2.50"
11 "	2.50"
12 "	2.50"
14 "	2.50"
16 "	2.50"
18 "	2.50"
20 "	3.00"
24 "	3.00"

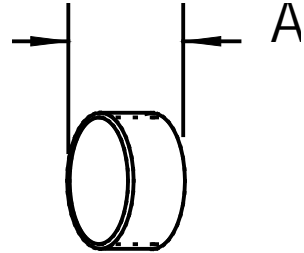
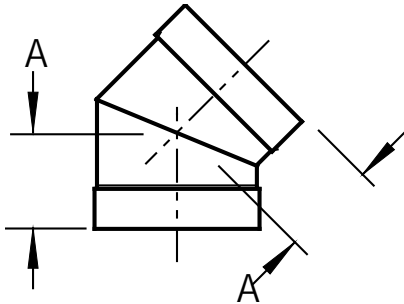

<b>45° Elbow Belled (2 piece)</b>			
<b>Part No.</b>	<b>Size</b>	<b>A</b>	<b>Approx. Wgt (Lbs)</b>
1834-45-02	2 "	3.000 "	0.5
1834-45-03	3 "	4.750 "	3
1834-45-04	4 "	4.937 "	2
1834-45-05	5 "	5.156 "	3
1834-45-06	6 "	5.375 "	3
1834-45-08	8 "	5.812 "	4
1834-45-10	10 "	6.250 "	5
1834-45-12	12 "	6.625 "	6
1834-45-14	14 "	6.875 "	6
1834-45-16	16 "	7.562 "	9
1834-45-18	18 "	8.000 "	10
1834-45-20	20 "	9.125 "	14
1834-45-24	24 "	10.000 "	21

<b>Coupling Sleeved</b>			
<b>Part No.</b>	<b>Size</b>	<b>A</b>	<b>Approx. Wgt (Lbs)</b>
1834-CP-02	2 "	4.000 "	0.5
1834-CP-03	3 "	4.000 "	1
1834-CP-04	4 "	4.000 "	1
1834-CP-05	5 "	4.500 "	2
1834-CP-06	6 "	4.500 "	1
1834-CP-08	8 "	4.500 "	2
1834-CP-10	10 "	4.500 "	2
1834-CP-12	12 "	4.500 "	2
1834-CP-14	14 "	4.500 "	2.5
1834-CP-16	16 "	4.500 "	3
1834-CP-18	18 "	4.500 "	3
1834-CP-20	20 "	4.500 "	4
1834-CP-24	24 "	4.500 "	5

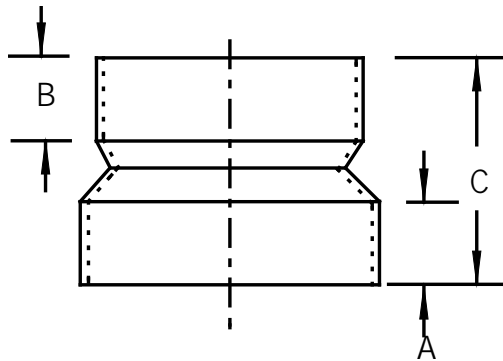

<b>Reducer Coupling One Step (Bell x Bell)</b>					
<b>Part No.</b>	<b>Size</b>	<b>A</b>	<b>B</b>	<b>C</b>	<b>Approx. Wgt (Lbs)</b>
1834-RC-0403	4" x 3"	1.750 "	1.750 "	7.000 "	1
1834-RC-0604	6" x 4"	2.000 "	1.750 "	7.000 "	2
1834-RC-0806	8" x 6"	2.250 "	2.000 "	8.000 "	2
1834-RC-1008	10" x 8"	2.500 "	2.000 "	8.000 "	3
1834-RC-1210	12" x 10"	2.500 "	2.500 "	8.000 "	4
1834-RC-1412	14" x 12"	2.500 "	2.500 "	7.250 "	4
1834-RC-1614	16" x 14"	2.500 "	2.500 "	9.000 "	5
1834-RC-1816	18" x 16"	2.500 "	2.500 "	8.250 "	5
<b>Two Step (Bell x Bell)</b>					
1834-RC-0804	8" x 4"	2.250 "	1.750 "	12.500 "	4
1834-RC-1006	10" x 6"	2.500 "	2.000 "	12.750 "	5
1834-RC-1208	12" x 8"	2.500 "	2.250 "	13.250 "	7
1834-RC-1410	14" x 10"	2.500 "	2.500 "	12.500 "	7
1834-RC-1612	16" x 12"	2.500 "	2.500 "	13.500 "	9
1834-RC-1814	18" x 14"	2.500 "	2.500 "	14.500 "	10
Rolled reducer couplings also available					

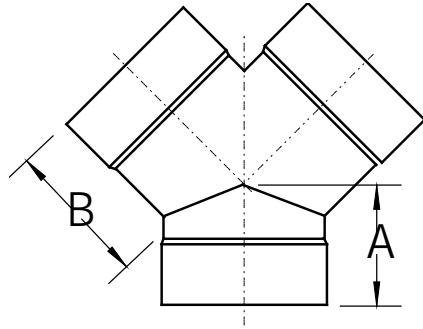
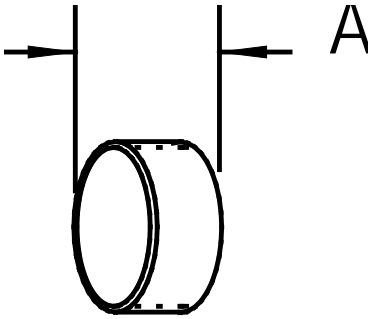

Cap (Beveled)			
Part No.	Size	A	Approx. Wgt (Lbs)
1834-CA-02	2 "	2.000 "	0.25
1834-CA-03	3 "	2.000 "	0.5
1834-CA-04	4 "	2.000 "	0.5
1834-CA-05	5 "	2.000 "	0.75
1834-CA-06	6 "	2.000 "	1
1834-CA-08	8 "	2.000 "	2
1834-CA-10	10 "	2.000 "	2
1834-CA-12	12 "	2.000 "	3
1834-CA-14	14 "	2.000 "	3
1834-CA-16	16 "	2.000 "	3
1834-CA-18	18 "	2.000 "	4
1834-CA-20	20 "	2.000 "	5
1834-CA-24	24 "	2.000 "	7

True Wye Beveled				
Part No.	Size	A	B	Approx. Wgt (Lbs)
1834-TY-02	2 "	2.750 "	2.375 "	0.5
1834-TY-03	3 "	3.250 "	4.750 "	2
1834-TY-04	4 "	4.000 "	5.250 "	3
1834-TY-05	5 "	4.375 "	5.750 "	4.5
1834-TY-06	6 "	4.437 "	6.250 "	3
1834-TY-08	8 "	5.812 "	8.375 "	6
1834-TY-10	10 "	6.250 "	9.500 "	9
1834-TY-12	12 "	6.656 "	10.250 "	11
1834-TY-14	14 "	6.875 "	11.000 "	13
1834-TY-16	16 "	7.312 "	12.000 "	16
1834-TY-18	18 "	7.750 "	13.000 "	23
1834-TY-20	20 "	8.250 "	13.750 "	30
1834-TY-24	24 "	10.750 "	18.000 "	49

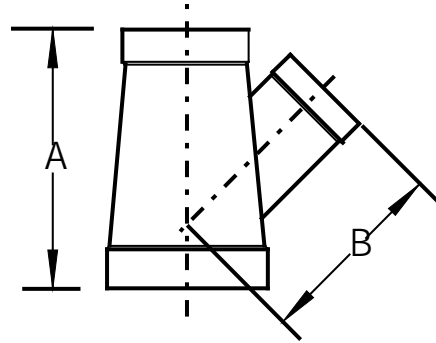
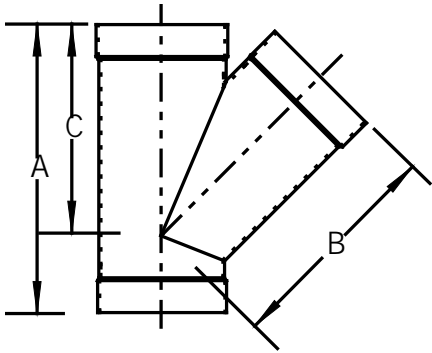

**45° Wye  
Beveled**

Part No.	Size	A	B	C	Approx. Wgt (Lbs)
1834-Y-0604	6 X 6 X 4 "	15.875 "	10.750 "	11.750 "	5
1834-Y-06	6 X 6 X 6 "	18.875 "	13.250 "	13.250 "	6
1834-Y-0804	8 X 8 X 4 "	16.375 "	12.250 "	13.062 "	6
1834-Y-0806	8 X 8 X 6 "	19.375 "	13.312 "	14.500 "	7
1834-Y-08	8 X 8 X 8 "	22.187 "	15.875 "	15.875 "	9
1834-Y-1006	10 X 10 X 6 "	20.375 "	15.312 "	16.250 "	9
1834-Y-1008	10 X 10 X 8 "	23.187 "	16.312 "	17.750 "	11
1834-Y-10	10 X 10 X 10 "	26.250 "	19.312 "	19.312 "	13
1834-Y-1208	12 X 12 X 8 "	23.312 "	17.750 "	18.750 "	13
1834-Y-1210	12 X 12 X 10 "	26.375 "	18.750 "	20.250 "	15
1834-Y-12	12 X 12 X 12 "	29.250 "	21.687 "	21.687 "	17
1834-Y-1410	14 X 14 X 10 "	26.250 "	19.625 "	20.875 "	16
1834-Y-1412	14 X 14 X 12 "	29.000 "	20.750 "	22.250 "	19
1834-Y-14	14 X 14 X 14 "	30.750 "	23.125 "	23.125 "	20
1834-Y-1612	16 X 16 X 12 "	29.000 "	22.125 "	23.375 "	21
1834-Y-1614	16 X 16 X 14 "	30.750 "	22.750 "	24.250 "	23
1834-Y-16	16 X 16 X 16 "	33.625 "	25.625 "	25.625 "	25
1834-Y-1814	18 X 18 X 14 "	31.250 "	24.250 "	25.375 "	26
1834-Y-1816	18 X 18 X 16 "	34.125 "	25.375 "	26.875 "	30
1834-Y-18	18 X 18 X 18 "	37.000 "	28.250 "	28.250 "	34
1834-Y-20	20 X 20 X 20 "	40.750 "	31.125 "	31.125 "	45
1834-Y-2418	24 X 24 X 18 "	38.000 "	30.750 "	31.750 "	49
1834-Y-24	24 X 24 X 24 "	46.500 "	36.000 "	36.000 "	71





<b>Tee Belled</b>				
Part No.	Size	A	B	Approx. Wgt (Lbs)
1834-T-0604	6 x 6 x 4 "	7.312 "	6.500 "	4
1834-T-06	6 x 6 x 6 "	7.562 "	7.562 "	4
1834-T-0804	8 x 8 x 4 "	8.312 "	6.750 "	5
1834-T-0806	8 x 8 x 6 "	8.562 "	7.812 "	5
1834-T-08	8 x 8 x 8 "	8.812 "	8.812 "	6
1834-T-1006	10 x 10 x 6 "	9.625 "	8.062 "	7
1834-T-1008	10 x 10 x 8 "	9.875 "	9.062 "	8.5
1834-T-10	10 x 10 x 10 "	10.125 "	10.125 "	10.5
1834-T-1206	12 x 12 x 6 "	10.625 "	8.062 "	8
1834-T-1208	12 x 12 x 8 "	10.875 "	9.062 "	9.5
1834-T-1210	12 x 12 x 10 "	11.125 "	10.125 "	11.5
1834-T-12	12 x 12 x 12 "	11.125 "	11.125 "	12
1834-T-1410	14 x 14 x 10 "	11.750 "	10.125 "	12
1834-T-1412	14 x 14 x 12 "	11.750 "	11.125 "	14.5
1834-T-14	14 x 14 x 14 "	11.750 "	11.750 "	16
1834-T-1612	16 x 16 x 12 "	12.750 "	11.125 "	15.5
1834-T-1614	16 x 16 x 14 "	12.750 "	11.750 "	17
1834-T-16	16 x 16 x 16 "	12.750 "	12.750 "	20
1834-T-1814	18 x 18 x 14 "	13.750 "	12.000 "	19.5
1834-T-1816	18 x 18 x 16 "	13.750 "	13.000 "	22
1834-T-18	18 x 18 x 18 "	14.000 "	14.000 "	26.5
1834-T-20	20 x 20 x 20 "	15.500 "	15.500 "	35
1834-T-2418	24 x 24 x 18 "	17.000 "	14.500 "	37
1834-T-24	24 x 24 x 24 "	17.500 "	17.500 "	55

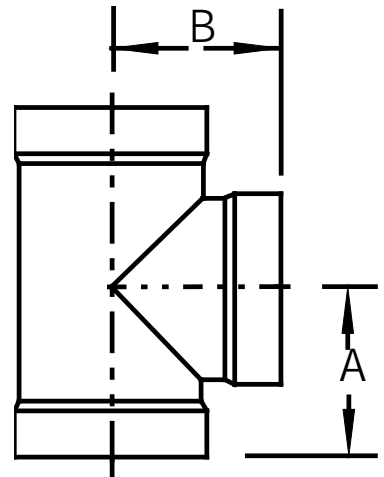

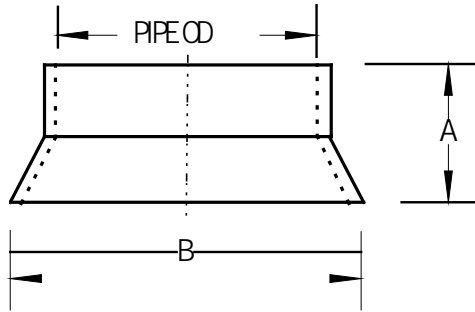

<b>Rainskirt Belled</b>				
Part No.	Size	A	B	Approx. Wgt (Lbs)
1834-RS-02	2 "	2.250 "	4.500 "	0.5
1834-RS-03	3 "	2.625 "	5.500 "	1
1834-RS-04	4 "	4.000 "	6.875 "	1
1834-RS-05	5 "	4.000 "	8.000 "	2
1834-RS-06	6 "	4.000 "	8.875 "	1
1834-RS-08	8 "	4.000 "	11.375 "	2
1834-RS-10	10 "	4.000 "	13.625 "	2
1834-RS-12	12 "	4.000 "	16.250 "	2
1834-RS-14	14 "	4.000 "	17.000 "	2.5
1834-RS-16	16 "	4.000 "	19.000 "	3
1834-RS-18	18 "	4.000 "	22.000 "	3
1834-RS-20	20 "	6.000 "	23.625 "	5
1834-RS-24	24 "	8.000 "	27.000 "	9

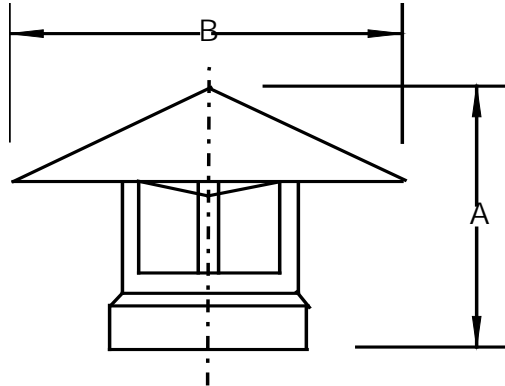

<b>Raincap 'Style A' Belled</b>				
Part No.	Size	A	B	Approx. Wgt (Lbs)
1834-WCA-02	2 "	8.000 "	4.000 "	1
1834-WCA-03	3 "	8.500 "	6.000 "	2
1834-WCA-04	4 "	9.000 "	8.000 "	2
1834-WCA-05	5 "	9.500 "	10.000 "	3
1834-WCA-06	6 "	10.500 "	12.000 "	3
1834-WCA-08	8 "	12.250 "	16.000 "	5
1834-WCA-10	10 "	13.500 "	20.000 "	7
1834-WCA-12	12 "	15.250 "	23.000 "	10
1834-WCA-14	14 "	16.000 "	28.000 "	13
1834-WCA-16	16 "	16.750 "	32.000 "	16
1834-WCA-18	18 "	17.500 "	36.000 "	21
1834-WCA-20	20 "	18.500 "	40.000 "	26
1834-WCA-24	24 "	19.000 "	44.000 "	33

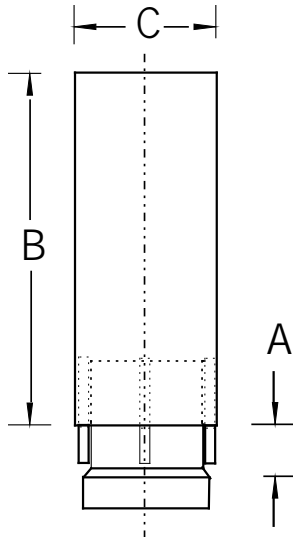

<b>Raincap 'Style B' Belled</b>					
Part No.	Size	A	B	C	Approx. Wgt (Lbs)
1834-WCB-02	2 "	6.000 "	8.000 "	3.500 "	2
1834-WCB-03	3 "	6.000 "	12.000 "	4.500 "	4
1834-WCB-04	4 "	6.000 "	16.000 "	6.625 "	6
1834-WCB-05	5 "	8.000 "	18.000 "	7.375 "	9
1834-WCB-06	6 "	8.000 "	24.000 "	8.625 "	10
1834-WCB-08	8 "	8.000 "	32.000 "	10.750 "	15
1834-WCB-10	10 "	8.000 "	40.000 "	12.750 "	22
1834-WCB-12	12 "	8.000 "	48.000 "	14.000 "	28
1834-WCB-14	14 "	8.000 "	56.000 "	16.000 "	36
1834-WCB-16	16 "	8.000 "	64.000 "	18.000 "	48
1834-WCB-18	18 "	10.000 "	72.000 "	20.000 "	65
1834-WCB-20	20 "	10.000 "	80.000 "	22.000 "	71
1834-WCB-24	24 "	12.000 "	96.000 "	26.000 "	102
Zero pressure loss feature					

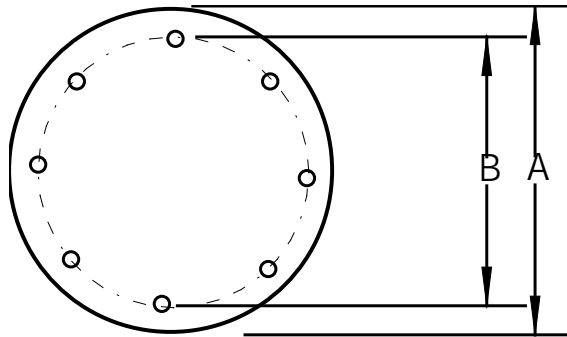

<b>Blind Flange</b>					
				<b># Bolt</b>	<b>Approx. Wgt</b>
<b>Part No.</b>	<b>Size</b>	<b>A</b>	<b>B</b>	<b>Holes</b>	<b>(Lbs)</b>
1834-BF-02	2 "	6.000 "	5.000 "	4	0.5
1834-BF-03	3 "	7.500 "	6.000 "	4	0.5
1834-BF-04	4 "	8.000 "	6.500 "	6	0.5
1834-BF-05	5 "	9.000 "	7.500 "	8	1
1834-BF-06	6 "	10.000 "	8.500 "	8	1
1834-BF-08	8 "	12.000 "	10.500 "	10	2
1834-BF-10	10 "	14.000 "	12.500 "	12	2.5
1834-BF-12	12 "	16.000 "	14.500 "	14	3.5
1834-BF-14	14 "	18.000 "	16.500 "	16	4
1834-BF-16	16 "	20.000 "	18.500 "	18	4.5
1834-BF-18	18 "	22.000 "	20.500 "	20	6.5
1834-BF-20	20 "	24.000 "	22.500 "	22	8
1834-BF-24	24 "	28.000 "	26.500 "	24	10
All flanges are 3/16" thick material					
All bolt holes are 5/16" diameter					

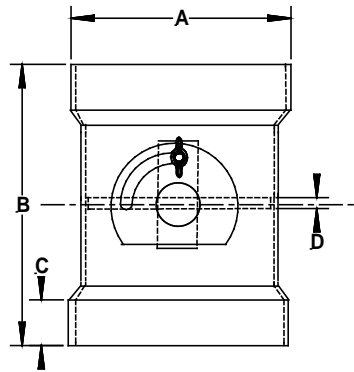

**Features and Benefits**

- \*Materials of Construction:  
Body, damper plate & shaft:  
PVC, CPVC, PP, HDPE
- \*Locking hardware: stainless steel
- \*Allows for less than 5% air-flow restriction
- \*Offers an approximate 95% seal
- \*Optional positive seal shaft & damper plate
- \*90° damper plate operation
- \*Can be installed vertically or horizontally
- \*Sizes Offered: 2" thru 24"
- \*Available with belled, socket, flanged, or spigot ends
- \*Optional electric motor actuated
- \*All plastic internal parts
- \*Furnished with locking quadrant damper allowing for permanent position set

Butterfly Damper Belled						
Part No.	Size	A	B	C	D	Approx. Wgt (Lbs)
1834-BD-02	2 "	2.375 "	6.750 "	1.500 "	.187 "	1
1834-BD-03	3 "	3.500 "	7.750 "	1.750 "	.187 "	2
1834-BD-04	4 "	4.500 "	8.500 "	1.750 "	.187 "	3
1834-BD-05	5 "	5.563 "	8.500 "	2.000 "	.187 "	3.5
1834-BD-06	6 "	6.625 "	9.500 "	2.000 "	.187 "	4
1834-BD-08	8 "	8.625 "	10.500 "	2.250 "	.187 "	5
1834-BD-10	10 "	10.750 "	11.750 "	2.500 "	.187 "	6
1834-BD-12	12 "	12.750 "	12.750 "	2.500 "	.187 "	8
1834-BD-14	14 "	14.000 "	13.750 "	2.500 "	.187 "	10
1834-BD-16	16 "	16.000 "	15.750 "	2.500 "	.187 "	11
1834-BD-18	18 "	18.000 "	17.750 "	2.500 "	.250 "	15
1834-BD-20	20 "	20.000 "	19.750 "	3.000 "	.250 "	20
1834-BD-24	24 "	24.000 "	23.750 "	3.000 "	.250 "	31

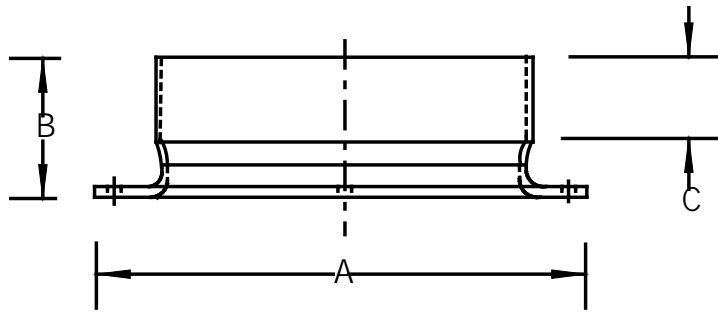

Flange Socket/Belled							
Part No.	Size	A	B	C	Bolt Circle	# Bolt Holes	Approx. Wgt (Lbs)
1834-SF-02	2 "	6.000 "	2.750 "	1.500 "	5.000 "	4	0.5
1834-SF-03	3 "	6.625 "	3.250 "	1.750 "	6.000 "	4	1
1834-SF-04	4 "	8.000 "	4.000 "	2.000 "	6.500 "	6	1
1834-SF-05	5 "	9.000 "	3.500 "	2.000 "	7.500 "	8	1.5
1834-SF-06	6 "	10.000 "	4.000 "	2.000 "	8.500 "	8	2
1834-SF-08	8 "	12.000 "	4.000 "	2.250 "	10.500 "	10	2
1834-SF-10	10 "	14.000 "	4.000 "	2.500 "	12.500 "	12	3
1834-SF-12	12 "	16.000 "	4.000 "	2.500 "	14.500 "	14	3
1834-SF-14	14 "	18.000 "	4.000 "	2.500 "	16.500 "	16	3
1834-SF-16	16 "	20.000 "	4.000 "	2.500 "	18.500 "	18	5
1834-SF-18	18 "	22.000 "	4.000 "	2.500 "	20.500 "	20	5
1834-SF-20	20 "	24.000 "	4.000 "	3.000 "	22.500 "	22	7
1834-SF-24	24 "	28.000 "	4.000 "	3.000 "	26.500 "	24	9
All flanges are 3/16" thick material All bolt holes are 5/16" diameter							

Note: Undrilled flanges also available

Flanges with 150# drilling available on a custom basis

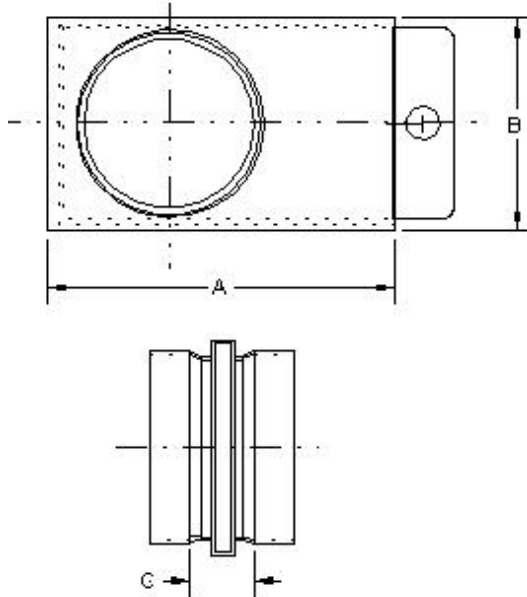

<b>Blastgate Belled</b>					
Part No.	Size	A	B	C	Approx. Wgt (Lbs)
1834-BG-02	2 "	6.000 "	3.750 "	1.000 "	1
1834-BG-03	3 "	7.000 "	4.880 "	3.250 "	2
1834-BG-04	4 "	8.000 "	5.560 "	3.250 "	3
1834-BG-05	5 "	11.000 "	8.880 "	5.000 "	3
1834-BG-06	6 "	11.000 "	8.880 "	5.000 "	4
1834-BG-08	8 "	14.000 "	10.250 "	4.000 "	6
1834-BG-10	10 "	17.000 "	12.380 "	4.500 "	8
1834-BG-12	12 "	20.000 "	13.880 "	4.500 "	11
1834-BG-14	14 "	21.750 "	15.500 "	4.500 "	11
1834-BG-16	16 "	23.000 "	17.500 "	4.250 "	15
1834-BG-18	18 "	28.000 "	19.500 "	4.250 "	20
1834-BG-20	20 "	30.750 "	21.500 "	5.750 "	27
1834-BG-24	24 "	34.000 "	25.500 "	5.750 "	31

Gate is 3/16" thick material.



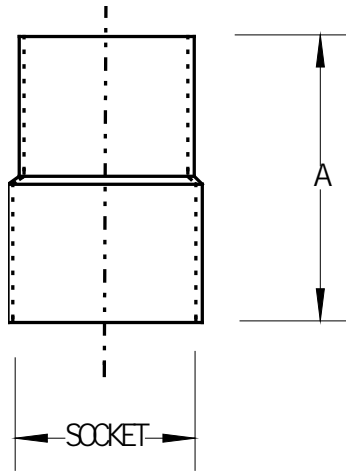

<b>Flex Hose Adapter Hose Spigot x Duct Bell</b>				
<b>Part No.</b>	<b>Size</b>	<b>Bell</b>	<b>A</b>	<b>Approx. Wgt (Lbs)</b>
	<b>O.D. (Hose)</b>	<b>Socket (Duct)</b>		
1834-FHA-02	2 "	2.375 "	5.500 "	0.5
1834-FHA-03	3 "	3.500 "	6.000 "	1
1834-FHA-04	4 "	4.500 "	7.000 "	1.5
1834-FHA-05	5 "	5.563 "	7.000 "	2
1834-FHA-06	6 "	6.625 "	7.500 "	2
1834-FHA-08	8 "	8.625 "	9.000 "	3
1834-FHA-10	10 "	10.750 "	9.000 "	4
1834-FHA-12	12 "	12.750 "	9.000 "	4
1834-FHA-14	14 "	14.000 "	8.000 "	4
1834-FHA-16	16 "	16.000 "	8.000 "	4.5
1834-FHA-18	18 "	18.000 "	8.000 "	5

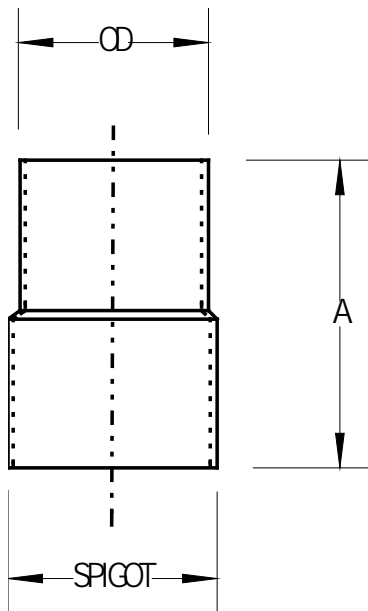

Flex Hose Adapter Hose Spigot x Duct Spigot				
Part No.	Size	Spigot	A	Approx. Wgt (Lbs)
	O.D. (Hose)	P.E. (Duct)		
1833-FHA-02	2 "	2.375 "	5.500 "	0.5
1833-FHA-03	3 "	3.500 "	6.000 "	1
1833-FHA-04	4 "	4.500 "	7.000 "	1.5
1833-FHA-05	5 "	5.563 "	7.000 "	2
1833-FHA-06	6 "	6.625 "	7.500 "	2
1833-FHA-08	8 "	8.625 "	9.000 "	3
1833-FHA-10	10 "	10.750 "	9.000 "	4
1833-FHA-12	12 "	12.750 "	9.000 "	4
1833-FHA-14	14 "	14.000 "	8.000 "	4
1833-FHA-16	16 "	16.000 "	8.000 "	4.5
1833-FHA-18	18 "	18.000 "	8.000 "	5



Hoods are fabricated to Harrison standards or customer specifications.

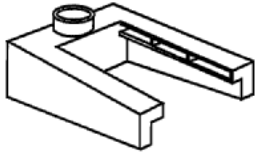

**Double Lateral Hood**

Lengths from 24" to 96"

Widths from 18" to 66"

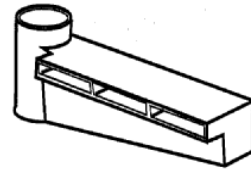

**Single Lateral Hood**

Lengths from 24" to 18 ft.

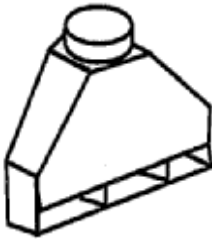

**Single Slot Rear Exhaust Hood**

Widths from 18' to 72"

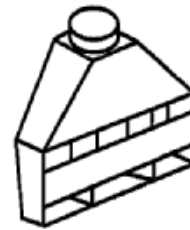

**Double Slot Rear Exhaust Hood**

Widths from 18' to 72"

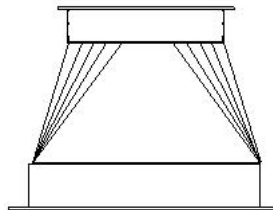

**Transitions**

Transitions (square to round, rectangular to round) with socket or flanged connections available per customer specifications. Transitions to dis-similar materials also available. Please contact us for pricing.